

## Note:

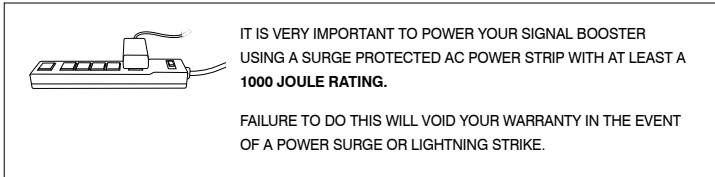

## Product Registration

Thank you for purchasing this weBoost product. Please take time to register your new product at our website:

<https://cellphonesignalbooster.us>

Registering is quick and easy, it only takes 2-3 minutes to complete. Your information is secure, we don't share or sell your information to other third parties.

This device complies with part 15 of the FCC Rules. Operation is subject to the following two conditions: (1) This device may not cause harmful interference, and (2) This device must accept any interference received, including interference that may cause undesired operation.

**RF Safety:** Any antenna used with this device must be located at least 8 inches from all persons.

FCC ID: PWO460001 IC 4726A-460001



111497\_Rev02\_01.30.15

## How It Works

Your cell phone is an essential part of your life. weBoost is here to ensure you have seamless connections on all your cellular devices.

The Connect 4G cellular signal booster is an effective solution to all those times you've had to walk into another room, or even outside, to find a stronger, more reliable cell signal. Installation is simple and can be completed with minimal tools.

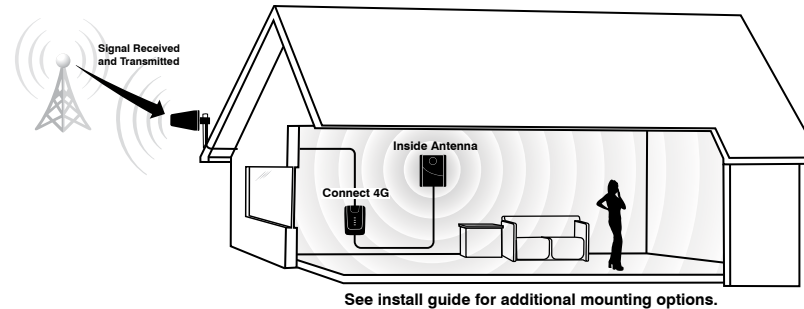

## NEED ASSISTANCE? WE CAN HELP!

Contact our U.S.- BASED CUSTOMER SUPPORT:

- Contact our U.S.-based customer support team at 1-800-501-3153 or email at [sales@cellphonesignalbooster.us](mailto:sales@cellphonesignalbooster.us)
- Go online for how to resolve the most common issues at <https://cellphonesignalbooster.us>
- Find a weBoost Installer on our web site at <https://cellphonesignalbooster.us>

Installation is simple, but we're here to make it even easier.



**Connect 4G™**  
Quick Install Guide

For more information refer to full Install Guide at:  
<https://cellphonesignalbooster.us>

## Package Contents

Connect 4G Signal Booster  
Panel Antenna Kit

Outside Antenna Kit  
AC Power Supply

Wall Mount Bracket  
Pole Mount Bracket

## Quick Install Diagram

Find the Strongest Signal

Outside Antenna Installation

Connect Coax Cables to Connect 4G

Inside Antenna Installation

Connect Power Supply

## 1 Find the Strongest Signal

Check the bar indicator on your cell phone display and note where the signal appears the strongest. NOTE: Cell phone bars are only an approximation of signal strength and vary from phone to phone. Be patient and repeat your signal check several times. NOTE: Create a "soft" install first by testing components in your proposed locations before securing them with hardware.

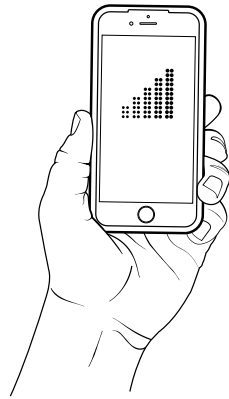

## 2 Outside Antenna Installation

Select a location on the roof or an outside wall where the Outside Antenna can be mounted without obstruction. After connecting the coax cable to the antenna, run it underneath the down side of your roof's flashing.

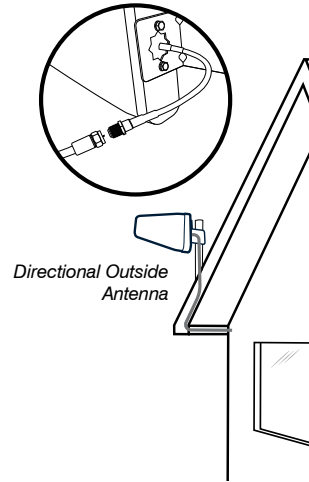

## 3 Connect Coax Cables to Connect 4G

Connect the coax cable from Outside Antenna to the Connect 4G. Connect the coax cable from Inside Antenna to the Connect 4G.

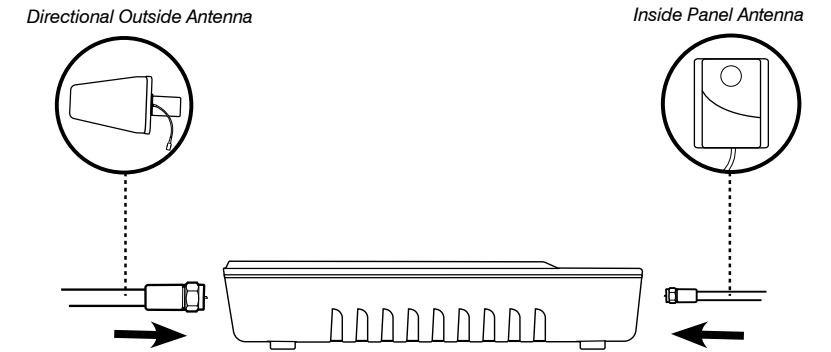

## 4 Inside Antenna Location

Maintain a vertical distance of at least 20 feet or a horizontal distance of at least 50 feet between the Outside Antenna to the Inside Antenna.

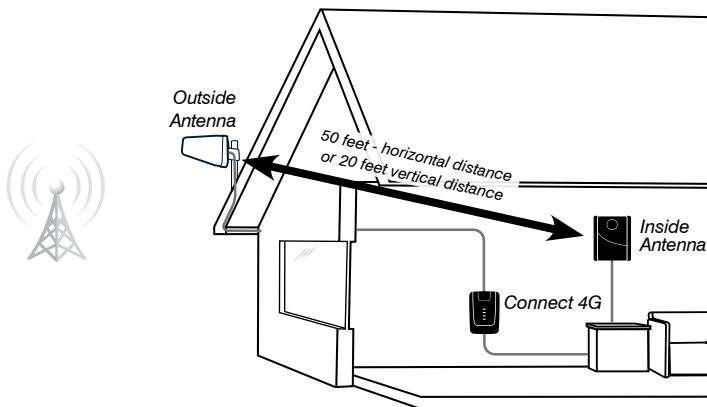

## 5 Inside Antenna Installation

After the desired location for the Inside Antenna has been determined use the Wall Bracket and hardware to mount to the wall.

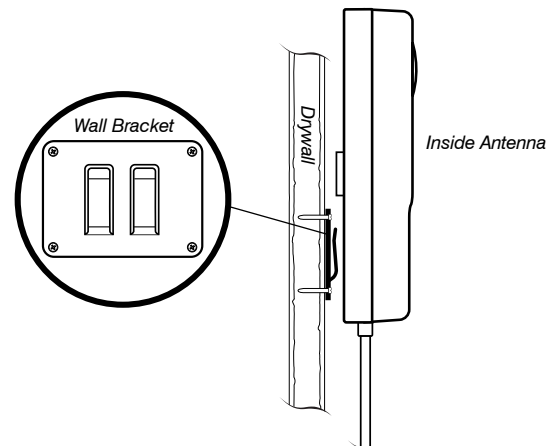

## 6 Connect to Power Supply

Connect the AC Power Supply to the Connect 4G then to a surge protected AC power strip with at least a 1000 Joule rating. If your Connect 4G is working correctly, the lights will be green.

NOTE: If lights (*lights may appear dim*) are not green on your weBoost booster, please refer to the full install guide online or contact customer support at 1-800-501-3153 or email at [sales@cellphonesignalbooster.us](mailto:sales@cellphonesignalbooster.us)

